

Zinc Testing and On-Site Calibration for Water Testing Detection Range: 1 – 15ppm

May 2018 Edition 1



Table of Contents

1	Testing and Calibration.....	3
1.1	Sample Collection	
1.2	Site Calibration	
1.3	Calibration Verification	
1.4	Procedure Considerations	
1.5	Testing	
2	General Information.....	8
2.1	Sensor Pack: Cuvette and Sensor	
2.2	Inserting Cuvette and Sensor	
2.3	Sample Injection and Measurement	
2.4	Pipetting Use Guidelines	
3	Sample Pretreatment.....	10
3.1	Important Notes	
3.2	Dilution	
3.3	pH Adjustment	
3.4	Filtration	
4	Troubleshooting.....	13
4.1	Basic Troubleshooting	
5	Technical Specifications for ANDalyze Sensors.....	14
5.1	Detection in Drinking Water	
5.2	Interference	
5.3	Product Accuracy Ranges	
6	Consumables and Replacement Items.....	15
7	Contact Information.....	16

1 Testing and Calibration

Important: Prior to operating this equipment, we highly recommend you read this entire manual in addition to the *ANDalyze Fluorimeter User Manual*. Pay attention to all danger, warning and caution statements. If the equipment is used in a manner not specified by the manufacturer, the safety features of this equipment may be impaired and injury to the operator or damage to the equipment may result.

1.1 Sample Collection

Water Sampling

For best results use freshly collected sample (unpreserved in acid) for analysis. We recommend that you use the sample within 1 hour (maximum of 2 hours) of collection to minimize any metal loss to the walls of the sample container. This is particularly important for testing trace zinc levels. Large volumes (1L) may be stored up to 12 hours in HDPE containers in a refrigerator or cooler with ice packs if required. Once the sample is mixed with ANDalyze sample buffer, test within 15 minutes.

Temperature Range

ANDalyze test kits typically work with water samples at 17 – 35 °C (63 – 95 °F) but for most accurate results, use sample at 20 - 25 °C (68 – 77 °F). Cold samples can be easily warmed by holding the sample vial in your hand for a short period. The sample quickly assumes the temperature of the sensor kit components so if the kit is at room temperature (~23C/73F), the sample will also likely be at that temperature during testing.

pH Range

The ANDalyze sample buffer that is provided in the sample tubes brings the pH of the test solution to pH 7.0. Generally, the raw sample water can be in the range of pH 5 – pH 8. If you have a sample which is acidic or basic, please check the pH first to confirm it is within the range prior to mixing with the ANDalyze buffer. The final buffered test solution should be ~pH 7.0 for best results.

Collection

(3) 30mL sample collection vials are included with each kit, however, almost any clean container may be used for tests if performed within a few minutes of collection. Please make sure to shake the sample well after any pretreatment is performed. See Section 3: *Sample Pretreatment* for further information.

Note: If using the same container for sample collection, between tests, rinse with new sample water to clean.

1.2 Site Calibration

Important: Site Calibration should be performed if testing is being done:

- At a new matrix which has not been previously saved (ex. municipality, pond, stream, etc.)
- To adjust for significant changes in sampling temperature.
- When beginning to use a new manufacture lot/batch of sensors.

Important: The below steps are for testing for dissolved, bio-available metal ions in drinking water samples. These steps can also be used for other matrices such as surface, ground, industrial and wastewater which have been pre-treated. Please see Section 3 for additional notes on *Sample Pretreatment* methods.

Matrix Effect and Standard Addition

The constituents of practically every water sample are different, each its own “matrix”. As observed in many modern analytical tests such as ICP, GC, and HPLC, some of these constituents may enhance or suppress the desired analytical signal (fluorescence in our case). This “matrix effect” makes it difficult to compare the signal between samples using the standard calibration curve, which the AND1100 fluorimeter contains from the time of manufacture.

To compensate for differences in each water matrix a “Site Calibration” is required to calibrate the AND1100 fluorimeter for that specific “site” and sensor kit. This is known as a “Standard Addition” method where a known analyte concentration (standard) is added to the sample matrix. The effect of this “spike” is then measured and compared against a sample of that same matrix but without the “spike”. The observed difference in of the two samples can then be related directly to the known analyte concentration, producing a “Factor”, which compensates for the influence the water matrix may have relating to the standard calibration curve. At the end of the process, the fluorimeter is calibrated for testing water at that site and provides results associated with that site. A calibration may only be accurate when originally performed, as changes in the sample matrix, temperature, and sensor lot will affect the results. Do not rely on a site calibration to be accurate over days as environmental samples can vary greatly. If in doubt, perform On-site Calibration.

Required Materials

- AND1100 Fluorimeter
- (2) 1mL Syringes
- (1) Transfer Pipette
- 100 μ L Pipette
- (2) Sensor Packs
- (2) 5mL Buffer Vials
- Zinc Standard Bottle
- Pipette Tip

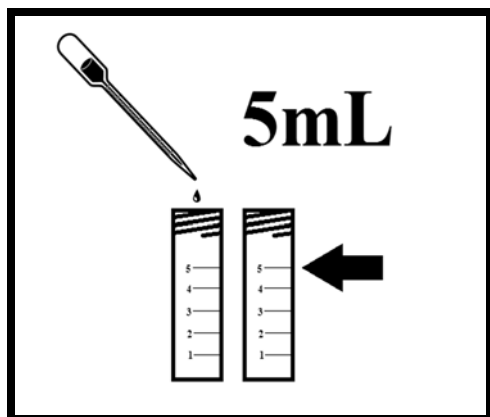

1. Fill TWO vials containing buffer to the 5mL mark with sample water using transfer pipette.

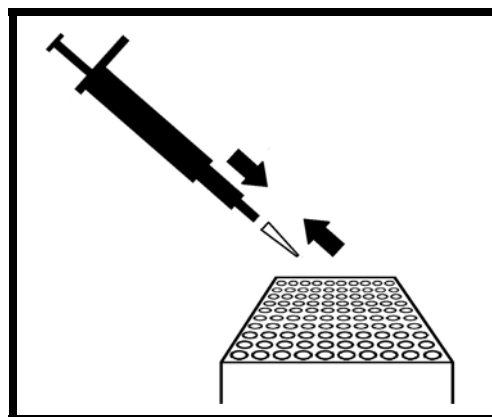

2. Place a new pipette tip onto 100uL fixed pipette.

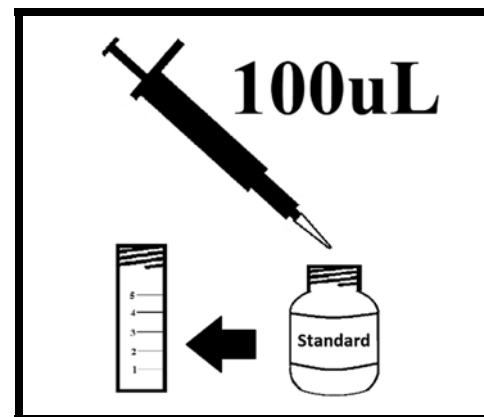

3. Using pipette, withdraw 100uL of Zinc Standard and dispense into ONE of the buffer vials (now "spiked").

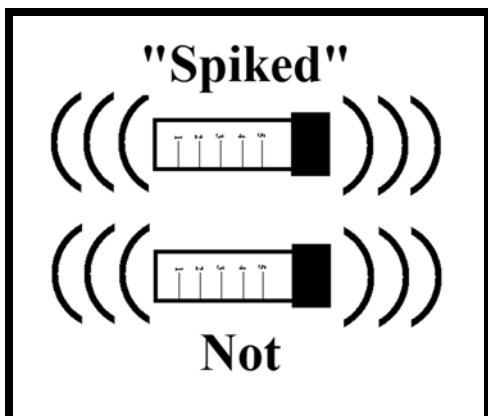

4. Screw on the white lids and shake to mix. Make note of which vial is "spiked".



5. Press **ON/OFF** to initialize AND1100 and confirm Zinc Sensor is selected. Press **SELECT** and create a "New Site" (ex. "DEMO").

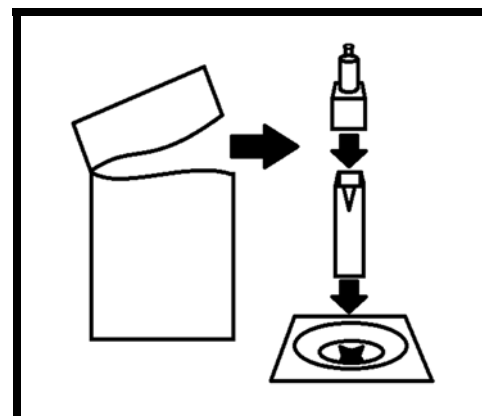

6. Open sensor pack, placing cuvette into AND1100 test chamber (triangle mark forward) and white sensor housing onto cuvette.

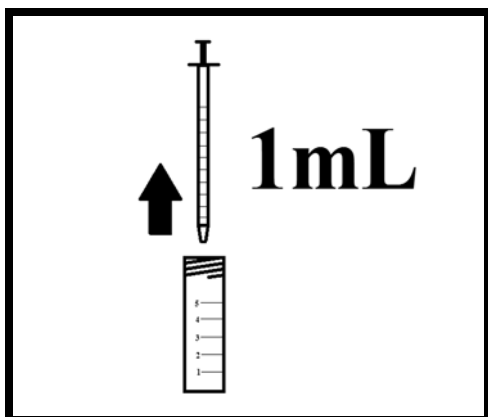

7. With a new syringe draw 1mL of sample WITHOUT spike from vial.

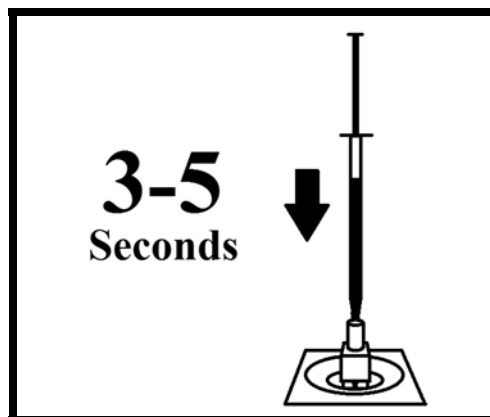

8. Attach syringe to top of sensor housing. Over 3-5 seconds, squeeze sample into cuvette.

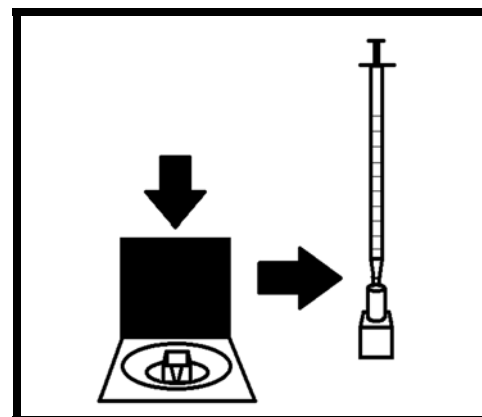

9. QUICKLY remove sensor housing and syringe, close AND1100 lid, and press Start.

Repeat Steps 6 through 9 with other "spiked" vial

10. When prompted, remove cuvette and repeat steps 6 through 9 with sample from "spiked" vial.

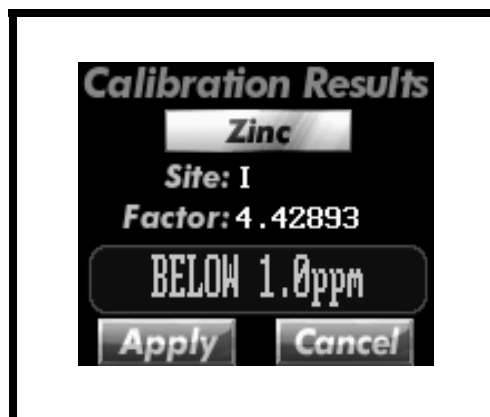

11. When prompted, remove cuvette to view sample results and apply the factor. Discard all materials used.



12. To test the next sample using this Site simply press Start to begin. See *Testing* section for procedure.

1.3 Calibration Verification

If desired (optional), the site calibration can be easily verified through performing a subsequent test using the same “spiked” sample used during the site calibration and the newly applied site calibration factor. Simply follow the instructions in the *Testing* section below using 1mL of the remaining 4mL “spiked” solution (originally 5mL with 100uL zinc spike) and compare the result with the concentration calculated below:

Step 1: Add the previous Site Calibration result to 5. (Example: 2.5ppm result + 5 = 7.5ppm)

Step 2: Is the subsequent test result from the “Spike” solution within 70-130% of this value?

YES – Proceed with additional tests on that site (sample matrix). This is an excellent method to verify that; 1) the user has performed the procedure correctly, 2) the AND1100 fluorimeter is operating correctly, and 3) the sensors and buffer are valid.

NO – Repeat Site Calibration. See *Procedure Considerations* and *Troubleshooting* sections below.

Important: Complete test within 15 minutes of mixing with ANDalyze buffer. Otherwise, use a NEW 5mL buffer vial with sample and 100uL spike (after 5 minutes). Recovery concentrations vary with other matrices.

Explanation

In the Site Calibration procedure, the 100uL “spike” increases the zinc concentration in the 5mL buffered sample by 5ppm, which is used for the standard addition calculation. The Site Calibration method will automatically calculate the concentration of zinc in the sample and indicate this on completion. The addition of those two concentrations (result and 5ppm spike) is what should be contained within the “Spiked” vial. It is important to note though that this is not a reflection of the accuracy of the technology as there is a compounding effect with this verification method. If higher accuracy is desired, users may repeat tests on the exact same solution and averaging the results.

Example: A site calibration result of 2.5ppm using the 15% Coefficient of Variation, found in our *Technical Specifications* section could indicate an actual concentration of 2.1 to 2.9ppm. Because the actual concentration could be at either end of the range, adding the 2.5ppm value to the 5ppm “spike” creates a potential level of inaccuracy (no longer a “known” concentration). Then by performing another test using that solution, the 15% of Coefficient of Variation would be applied again, resulting in the 70-130% range as used for the calculation.

1.4 Procedure Considerations

- Consistency is important for improved accuracy. Repeat your steps as closely as possible (examples: 3-5sec injection of precisely 1mL, close lid, and press start immediately)
- All components in a sensor kit (cuvette, sensor housing, 1mL syringe, buffer vial, pipette tip) are meant to be used only once and are disposable. No special treatment required as all materials are non-hazardous.
- Kits are color coded and labeled for each metal. For example, Zinc testing will use a white sensor housing, buffer caps, and fluorimeter display.
- Test with fluorimeter on a flat surface (i.e. Inner surface of provided fluorimeter case)
- Open the 5mL vials carefully so that the buffer liquid buffer does not spill out. When adding the sample water, you can slowly pour the water into the vials up to the 5 mL mark and use one of the provided disposable plastic pipettes to transfer water accurately. Do not exceed the 5 mL mark for accurate results.
- If the unit is left on for more than a few minutes without any activity, a screen-saver (black screen) will be activated (user settable); press any button to resume operation (Do not press and hold ON/OFF).
- All waste produced during the test can be disposed of in normal public receptacles. Materials and liquids used are not considered harmful to people or the environment and do not require special disposal. The plastic waste is made from recyclable plastics and can be disposed of per local guidelines.

1.5 Testing

Important: Site Calibration of the sample is recommended prior to further testing of that sample.

Required Materials

- AND1100 Fluorimeter
- (1) Sensor Pack
- (1) 1mL Syringe
- (1) 5mL Buffer Vial
- Sample Water



1. Press **ON/OFF** to initialize AND1100. Confirm correct Sensor and Site setting.

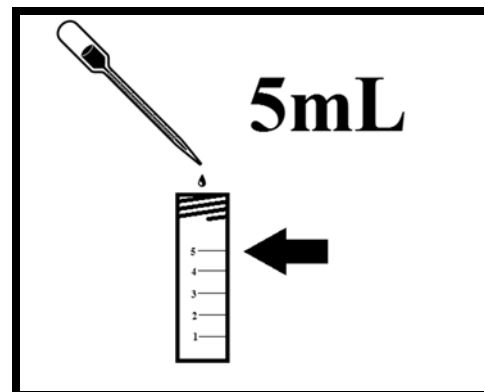

2. Fill vial containing buffer to the 5mL mark with sample water using transfer pipette.

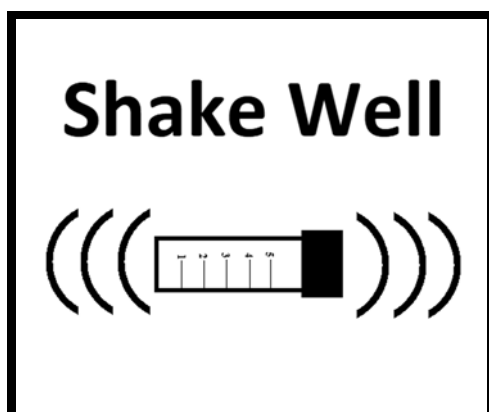

3. Screw on lid and shake to mix.

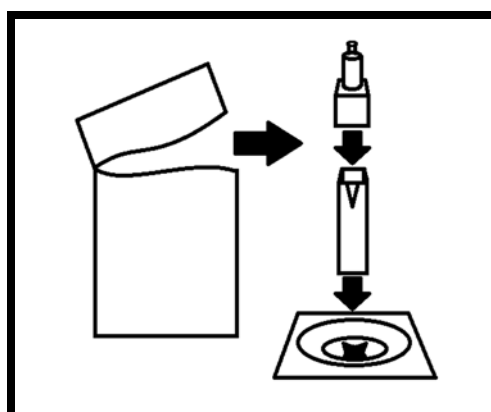

4. Open sensor pack, placing cuvette into AND1100 test chamber (triangle mark forward) and green sensor housing onto cuvette.

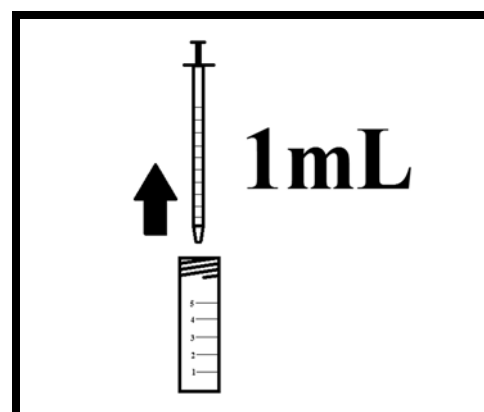

5. With a new syringe draw 1mL of sample from vial.

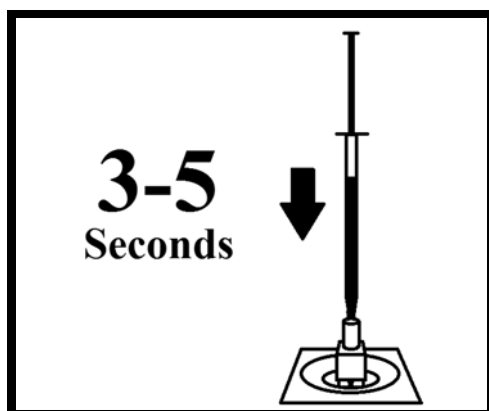

6. Attach syringe to top of sensor housing. Over 3-5 seconds, squeeze sample into cuvette.

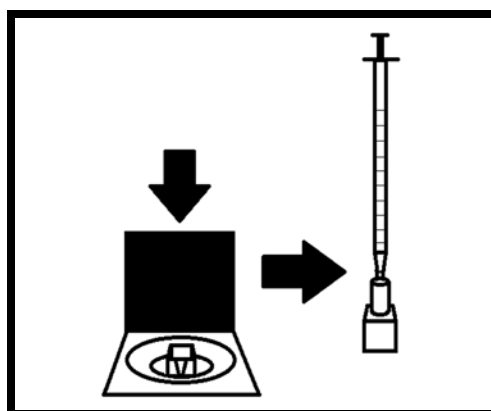

7. **QUICKLY** remove sensor housing and syringe, close AND1100 lid, and press Start.

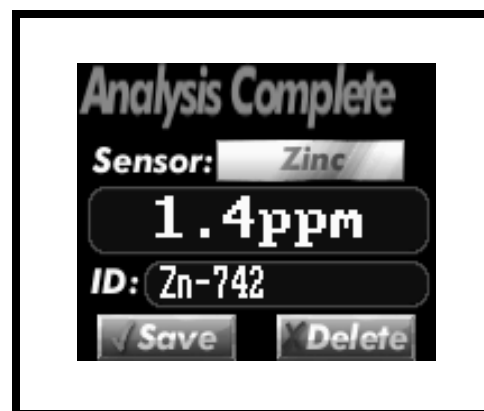

8. When prompted, remove cuvette to view and save results. Discard all materials used.

2 General Information

2.1 Sensor Pack: Cuvette and Sensor

Sensor Pack: Each sensor pack contains a cuvette, a sensor and a desiccant. These are **single use** and must be discarded. The desiccant should be blue in color. If it has turned completely pink in color, the sensor may not perform well.



2.2 Inserting Cuvette and Sensor

Cuvette: The cuvette has an arrow which should face you when inserted. Insert the cuvette completely so that the fluorimeter lid can close. The meter and cuvette design help to prevent improper orientation.

Sensor: The square portion of the sensor can be placed on the cuvette in any orientation with the round sections facing upward. Sensors can only be used once and should be disposed of immediately after use.

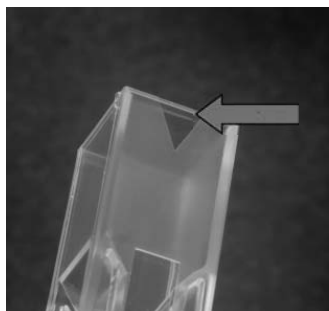
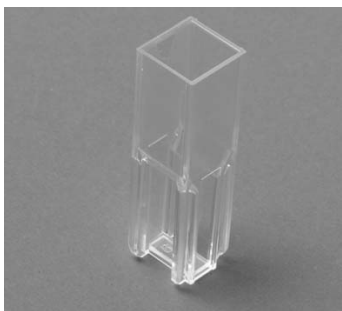

2.4 Sample Injection and Measurement

The ANDalyze Fluorimeter should be **laid flat** on a stable surface during a measurement.

A buffered solution is prepared in a sample tube as described in the On-Site Calibration section (3) and test section (4) and this is used for measurements.

A new 1 mL syringe should be used to withdraw 1 mL buffered sample water from a sample tube. This syringe can be attached to the top of the housing as shown in the picture.

The sample should be injected through the housing into the cuvette at a constant speed over **3 – 5 seconds**. The syringe and housing should be immediately removed and the sample door closed. The **START** button located just below the screen should be pressed immediately to start any measurement.

Important: After each analysis, discard all components used during the analysis including cuvette, sensor housing, sample tube, and syringes to avoid cross contamination.



2.5 Pipette Use Guidelines

- 1. New Pipette Tip** – Attach a new tip by placing the end of the pipette into one of the available tips and pressing down on the pipette body.

Note: Tips are disposable and should never be used more than once. Use of tips helps prevent contaminating the pipette.



- 2.** Depress the plunger button on the top to the first stop (see photo at left). **DO NOT depress all the way to the pipette body.**
- 3.** Immerse the clean tip into the solution to be withdrawn.
- 4.** Release the pressure slowly to withdraw the solution into the tip.

Important: Make sure that the pipette tip continues to be immersed in the solution during release so as to not expose the tip point to air.

- 5.** Remove the pipette from the solution.

Note: The liquid level in the tip should be approximately at the 3rd graduation.

- 6.** Immerse the tip into the liquid present in the sample tube where the withdrawn solution is to be dispensed.
- 7.** Slowly depress the operating button **ALL THE WAY** to dispense the liquid contained in the pipette tip. (See photo at right)

- 8.** Remove the pipette and discard the used tip.

Note: Dispose of tips immediately after use to prevent possible contamination of the pipette.



3 Sample Pretreatment

ANDalyze test kits are designed for use “out of the box” with drinking water; however, they can be used for analysis of other water matrices with some minor protocol modifications. This section contains instructions for various pretreatments that may be required for samples obtained from other sample sources such as those indicated in the chart below and which pretreatments are recommended and/or required them:

ANDalyze Kit Part Number:		Filtration	Dilution	pH Adjustment	Acid Digestion	Other*
		AND900	AND901	AND903	N/A	N/A
Municipal						
Drinking	Municipality					
	Plumbing/Pipes	Recommended				
Ground						
	Wells	Required	Recommended			
	Mining	Required	Recommended	Recommended		Recommended
	Hazmat sites	Required	Recommended			Recommended
Surface (River/Pond/Lake)						
Natural	Environmental	Required				
	Irrigation	Required				
Salt Water						
	Brackish	Required	Required			Recommended
	Seawater	Required	Required			Recommended
Industrial						
Waste	Inlet Boiling/Cooling Tower	Required	Required	Recommended	Recommended	Recommended
	Process Wastes	Required	Required	Recommended	Recommended	Recommended
Municipal						
	Final Effluent	Required	Required	Recommended	Recommended	Recommended

* May require additional testing to identify potential other interference

Each matrix type may require one or more of the following pre-treatment kits, which are available through ANDalyze. However, individual components have been listed also, which may be purchased through a scientific supply company as well.

ANDalyze Dilution Kit

- 50 mL Self-standing sample tube
- 5 mL Fixed Volume Pipette & Tips
- Reagent grade deionized or distilled water

ANDalyze pH Adjustment Kit

- Sodium Hydroxide Neutralization Solution, 1% (w/v) sodium hydroxide in a dropper bottle
- Nitric Acid Neutralization Solution, 1.5% (w/v) nitric acid in a dropper bottle
- pH paper

ANDalyze Filtration Kit

- 0.45 µm Nylon filter, 25 mm diameter (Nalgene)
- 20 mL Syringe
- 50 mL Self-standing sample tube

3.1 Important Notes

- When testing a sample after any pretreatment, perform a Site Calibration initially. After a successful Site Calibration, continue this same pretreatment on every sample while testing for that analyte using that site. If a different pretreatment is required or significant time has passed (matrix changes), a new Site Calibration should be performed.
- Tests have shown that environmental samples preserved in acid to a pH < 2 cannot be brought to a pH of 7.0 when mixed with the ANDalyze buffer. These samples must be first neutralized with NaOH to a pH ~5 before mixing with ANDalyze buffer.
- The percent recovery for analytes in samples requiring pretreatment may be significantly lower than indicated in the *Technical Data* section due to a variety of factors. For example, some environmental samples requiring filtration may only recover about 60% of the analyte originally contained in the sample due to some absorption by particulates that are filtered out. A full acid digestion may be required to extract all potential analytes.
- After dilution, all solutions should be shaken well.

3.2 Dilution

Dilution involves taking a small amount of sample water then adding distilled or deionized (DI) water (aliquot), which contain no interferences, to make a new solution with a larger volume but a lower concentration than the original sample. Dilution is needed for accurate readings when:

- The target metal ion is present at a concentration higher than the linear detection range (i.e. 15ppm for zinc). If the concentration is unknown, the device will generally indicate an “Above Limit” on the results page.
- Interferences are exceptionally high or unknown and a Site Calibration is unsuccessful.

With any dilution, the displayed result (concentration) after the test, must be multiplied by a factor to account for the dilution. This is the number usually followed by an “X” when describing a dilution (i.e. 4X dilution contains 1 part sample and 3 parts DI water). This factor can be calculated by dividing the Total Volume by the Sample Volume (i.e. 50mL total volume divided by 5mL sample = 10, 2.5ppm result x 10 = 25ppm in original solution).

Use of 30mL Sample Vials (Included with Kit)

- Using the graduations on the 30mL sample water vial, users can make a 2X to 6X dilution by adding sample to the 10mL mark and then filling to 20mL (for 2X) or 30mL (for 3X) mark with DI water or by adding sample to the 5mL mark and then filling to the 20mL (4X), 25mL (5X), or 30mL (6X) mark with DI water.
- For a higher dilution, the 100uL pipette used for Site Calibration (and new pipette tip) can be used. By adding 100uL of sample to the 30mL vial and then adding DI water to a specific mark, users can achieve 50X through 300X dilutions.

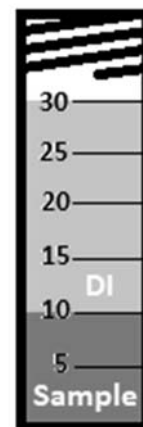

Using ANDalyze Dilution Kit (Purchased Separately)

By withdrawing 5mL of sample with the 5mL fixed volume pipette, adding it to the 50mL self-standing tube then filling with DI water to the 50mL mark, a 10X dilution can be created.

Note: Use of glassware is not recommended for samples with metal due to adsorption to the walls.

3.3 pH Adjustment

ANDalyze sensors perform best when the sample pH is between 5 and 8. Samples with a pH greater than 8 or below 5 will not test reliably so it is required to adjust the pH of the sample to be within this range before site calibration or testing. Samples above pH 10 should not be tested even with pH adjustment.

Procedure

1. **Check the sample pH** using pH paper.
2. **Adjust the sample pH**

- **If the sample is below pH 5** addition of a dilute sodium hydroxide solution is necessary. To a 30mL volume of sample add the Sodium Hydroxide Neutralization Solution dropwise with stirring or with shaking between addition of each drop. Do not adjust beyond pH 5.

Note: pH change from 4 to 5 is rapid, requiring a half drop or less. **Check the pH multiple times during titration.** The number of drops required depends heavily on matrix constituents. As few as four drops may be sufficient to increase pH from 3 to 4, or many more may be required.

- **If the sample is above pH 8** addition of a dilute nitric acid (1.5 %) solution is necessary. For highly basic water samples, acidification may be insufficient as metal ions may have already precipitated out of solution.

Note: pH change from 9 to 8 is rapid, requiring a half drop or less depending on matrix. **Check the pH multiple times during titration.** The number of drops required depends heavily on matrix constituents. As few as four drops may be sufficient to decrease pH from 10 to 7, or many more may be required.

3.4 Filtration

Before performing a Site Calibration or testing any water sample that may contain high turbidity or particulates, it must be filtered to remove suspended solids.

Procedure

1. Draw ~20 mL of sample into a 20mL syringe.
2. Securely attach the syringe filter to the syringe.
3. Slowly push the sample through the filter into the self-standing vial. The sample should be clear and the filter may no longer be white.

Note: If the sample is collected off-site and transported to a laboratory for testing, the EPA recommends that the user ensures that the sample is stirred (e.g. place a stir-bar in the bottom of a 1L HDPE Nalgene bottle filled with sample on a stir plate) while filling the syringe to ensure homogeneity. For most applications ANDalyze recommends simply shaking well.

Note: If a sample contains a great deal of suspended solids the syringe filter may clog after elution of 10-20mL of sample. In this case, discard the clogged filter and use a fresh filter to continue filtering the sample.

4 Troubleshooting

NON-Potable samples such as environmental and industrial samples will likely need pre-treatment (filtration, dilution, pH adjustment, digestion, etc.). Use of deionized or distilled water can be used for the sample when testing to eliminate sample interference as a potential issue, since they should contain no interferences, are at a neutral pH and generally at room temperature. If tests work well with deionized or distilled water, original (issue) water sample can be diluted to reduce interferences. Please see *Sample Pretreatment* section for instructions to dilute.

4.1 Basic Troubleshooting

Observation	Potential Causes	Potential Solutions
Below Limit Result	<ul style="list-style-type: none"> Target metal IS below minimum detection level (ex. 1ppm Zinc) Water conditions affect fluorescence detection Sensor Kit expired or degraded 	<ul style="list-style-type: none"> Confirm temperature and pH are within range and sensor kit expiration and storage conditions Filter sample if non-potable (0.45um Nylon filters)
Above Limit Result	<ul style="list-style-type: none"> Target metal IS above maximum detection level (ex. 15ppm Zinc) 	<ul style="list-style-type: none"> Dilute Sample (Make sure to multiply result by dilution (ex. 5ppm with a 4x dilution is actually 20ppm))
Result Not As Expected	<ul style="list-style-type: none"> Interference Adsorption to Container Organic Absorption Incorrect 100uL pipette operation 	<ul style="list-style-type: none"> All the above Repeat Site Calibration Confirm 100uL “spike” level is at line on pipette tip Consistency is key!
Site Calibration Failed	<ul style="list-style-type: none"> Fluorescence difference between “spiked” and non-spiked samples not observed “Spiked” and non-spiked vials switched Interference 	<ul style="list-style-type: none"> All the above Sample dilution (2x or 4x) may reduce interferences

If issues or concerns persist, or if you have questions, please call or email ANDalyze.

5 Technical Specifications

5.1 Detection in Drinking Water

ANDalyze's proprietary catalytic DNA sensor uses a DNAzyme reaction that fluoresces in the presence of the target contaminant (lead, uranium, copper, etc). The fluorescence of the reaction is measured using the ANDalyze fluorimeter to determine the concentration of the free analyte ion (Pb^{2+} , UO_2^{2+} , Cu^{2+} , etc.) in solution and is reported in parts per billion (ppb) or parts per million (ppm).

Materials Used

- ANDalyze Fluorimeter
- Zinc Sensor Kit
- Analyte/Metal Standard Solution



Sensor

Associated US Patents

8,815,156B2, 6,706,474, 7,192,708,
6,890,719, 7,332,283

Performance

Zinc dilutions containing 0, 0.5, 1, 2, 5, 10, 15, 20, 25 ppm Zn^{2+} were prepared in DI water. Five replicates were made for each test at each dilution.

Limit of Detection (LOD)

0.3 ppm Zn^{2+}
Based on 3 sigma method

Precision

Standard: 5 ppm Zn^{2+}
95% Confidence Limits: 4 - 6 ppm Zn^{2+}

Limit of Quantification (LOQ)

1 ppm Zn^{2+}
Based on 10 sigma method

Coefficient of Variation (CV):

1 – 15 ppm $\text{Zn}^{2+} \pm 20\%$ or 1ppm, whichever is greater
Note: This data is for tests in DI water. Environmental and other matrix variations will be higher.

Linear Detection Range

1 – 15 ppm Zn^{2+}

Note: All specifications are subject to change without notice.

5.2 Interference

Interference tests were done with a 5ppm Zn^{2+} solution plus the potential interfering ion. The interference tolerance levels represent the concentration above which the zinc concentration is changed to $\pm 20\%$. Data represents an average of at least three replicates. For each interference test, an on-site calibration with the particular water matrix (containing the interfering ion) was performed.

Interfering ion	Interference level
Calcium, Ca^{2+}	300 ppm
Magnesium, Mg^{2+}	300 ppm
Aluminum, Al^{3+}	100 ppb
Copper, Cu^{2+}	100 ppb
Iron, Fe^{3+}	80 ppb
Lead, Pb^{2+}	30 ppb
Cadmium, Cd^{2+}	20 ppm
Manganese, Mn^{2+}	10 ppm
Ammonium, NH_4^+	1000 ppm
Carbonate, CO_3^{2-}	250 ppm
Phosphate, PO_4^{3-}	300 ppm
Sulfate, SO_4^{2-}	2000 ppm
Nitrate, NO_3^-	3000 ppm

5.3 Product Accuracy Ranges

The graphs below depict the average measured Zn^{2+} concentration as displayed on the ANDalyze fluorimeter (y-axis) vs. the known concentration of the zinc standards (x-axis). Error bars depict the standard deviation from five measurements. Figure 1 shows the linear range of 0 – 15 ppm Zn^{2+} . For higher concentrations of Zn^{2+} (tested up to 25 ppm Zn^{2+}), the accuracy decreases (Graph 2). Samples containing higher than 15 ppm Zn^{2+} can be diluted 1:1 and re-analyzed.

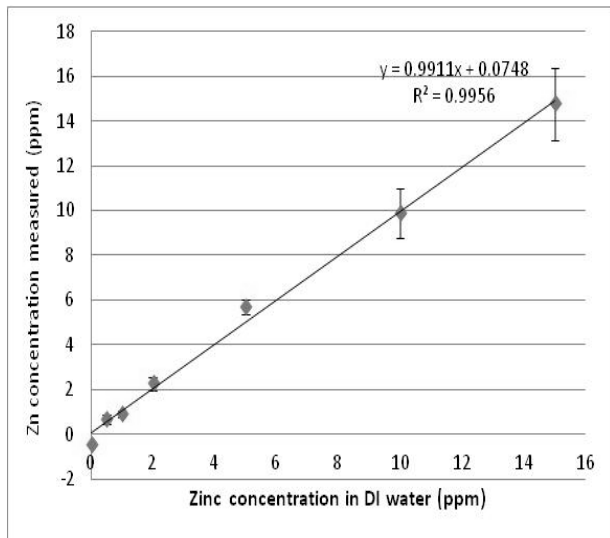

Graph 1: Average Zn^{2+} Conc. vs. Known Conc.

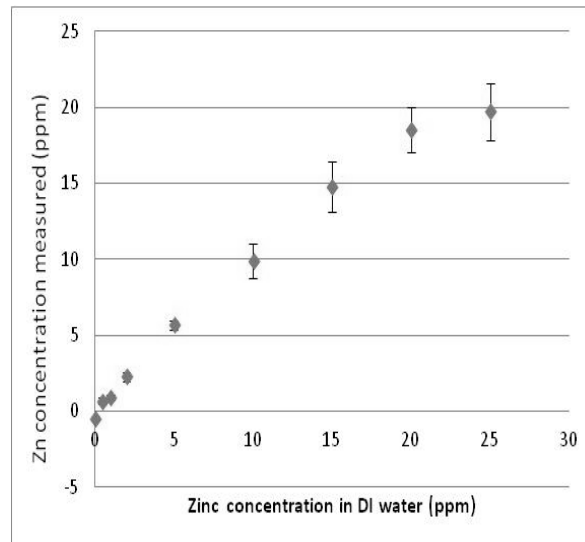

Graph 2: Accuracy vs. Linear Detection Range

6 Consumables and Replacement Items

- Fluorimeter (Part Number: AND002)
 - o Includes: AND1100 Fluorimeter
 - USB to MINI-B Cable
 - 100 μ L Fixed Volume Pipette and Tips
 - pH Test Strips
 - User Manual

- Sensor Kit (Part Number: AND015)
 - o Kit Includes: (25) Sensor Packs with Sensor & Cuvette
 - (25) Sample Tubes (with buffer)
 - (25) 1 mL Syringes
 - (15) Disposable Transfer Pipettes
 - (3) 30mL Sample Vials
 - 5 mL Zinc Standard Solution (230 ppm Zn^{2+})
 - Instruction Manual
 - Material Safety Data Sheets (MSDS)

7 Contact Information

Contact us by Email:

info@andalyze.com

sales@andalyze.com

By Telephone:

866.364.7173 (Toll Free in US) or +1 217.328.0045

By Fax:

+1 857 386 1277

Business Service Hours:

8:00am to 5:00pm Central Standard Time (USA) Monday through Friday

Company Address:

ANDalyze Inc.

902 N Country Fair Dr

Suite 8

Champaign, IL 61821

Website:

www.andalyze.com



ANDalyze Inc.

902 N Country Fair Dr, Suite 8

Champaign, IL 61821 USA

Email: info@andalyze.com

Telephone: +1 217 328 0045